



MANUFACTURER AND EXPORTER

An ISO 9001 : 2008 Certified Company

PRODUCT CATALOG

☎ +918360945060, +919988804251

✉ export@gkgindustry.com, vikram@gkgindustry.com;

🌐 <https://gkgindustry.com/>

📍 D-135, Phase V, Focal Point Ludhiana - 141110. Punjab (INDIA)



Scan QR
To know more

ABOUT US

GKG Industry is a leading **Manufacturer and Exporter of Garden Hardware, Scaffolding & Formwork.**

Our products are engineered in India and transported to happy clients worldwide, and we have been delivering competitive customer-driven solutions to our growing international clientele for over 20 years.

We pride ourselves in offering customisable products made and assembled by highly qualified and experienced professional personnel and staff.

Our organisation provides a diverse product portfolio which includes a wide durable range of pole anchors & ground plates, timber connectors, drop-forged couplers and scaffolding & formwork.

All of our merchandise & its components are manufactured using high-grade quality raw materials and are available to be customised to the needs and specifications of our clients. We also have our own in-house advanced Hot Dip Galvanising Plant.

OUR MISSION AND PRIORITY

It is to our utmost concern that we :

- Deliver goods exactly in accordance with the customer's wishes.
- Strive for swift, hassle-free delivery to the customer.
- Make any development to the specifications and drawings of our clients.
- Offer packaging services to satisfy our prestigious customers.
- Provide accurate and fast information after the receipt of any query.
- Supply quality at the best possible price & achieve total customer satisfaction

Our endeavours are focused on customer satisfaction.

To achieve this, continuous efforts are made towards excellence in all aspects.

Customer needs are anticipated, and regular brainstorming generates new ideas to meet market demands.

QUALITY POLICY

All our products are manufactured under stringent quality control measures. Quality has become integrated with the company culture and the quality system used is in compliance with the best standards in the world.

Our expert technicians monitor the production process to ensure high-quality international standards. We use only premium quality raw materials and adopt strict quality control methods, supervised by a team of highly educated and technically qualified inspectors at all stages of manufacturing, from inception to the final product.

GKG Industry undertakes to remain synonymous with high-calibre products. Satisfaction is guaranteed to our customers through our tested quality assessment protocols and the constant training and education of our working professionals.

GKG Industry stands for total customer satisfaction through value for money, pricing, best quality, timely delivery and is committed to continually improve its quality management system.

With the prime objective of maximizing the satisfaction level of our customers, we make dedicated efforts in bringing out the most diverse range of manufacturer and exporter of Garden Hardware and Scaffolding framework solutions to our customers. Our team of professionals plays an important role by working in close coordination with our customers. We understand the exact requirements of our customers and come up with application specific products so as to fulfil their demands. Further, our ethical business policies and transparent dealings have helped us in winning the trust of our customers

Wood Connector

POLE ANCHORS AND GROUND PLATES



POLE ANCHORS FOR SQUARE POST

Certification:

ISO

Finish :

Hot-dip galvanized

Size
46x46x600mm
51x51x600mm
51x51x750mm
61x61x750mm
71x71x750mm
71x71x900mm
91x91x750mm
76x76x750mm
91x91x900mm
96x96x750mm
96x96x900mm
101x101x750mm
101x101x900mm
121x121x750mm
121x121x900mm
141x141x750mm
141x141x900mm
146x146x750mm
146x146x900mm
151x151x750mm
151x151x900mm

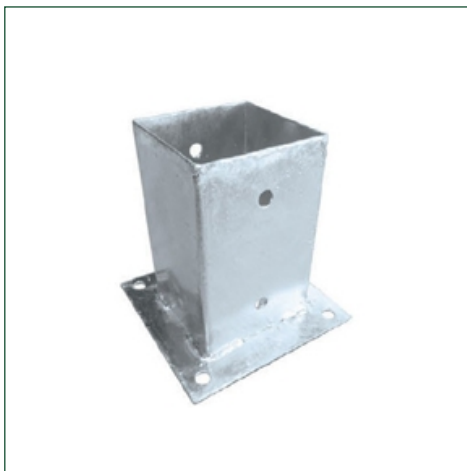

GROUND PLATES FOR SQUARE POST

Certification:

ISO

Finish :

Hot-dip galvanized

Size
61x61x150mm
71x71x150mm
76x76x159mm
81x81x150mm
91x91x150mm
96x96x150mm
101x101x150mm
121x121x150mm
141x141x150mm
146x146x150mm
151x151x150mm



POLE ANCHORS FOR ROUND POST

Certification:

ISO

Finish :

Hot-dip galvanized

Size
81x81x750mm
101x101x750mm
101x101x900mm
121x121x750 mm
121x121x900mm

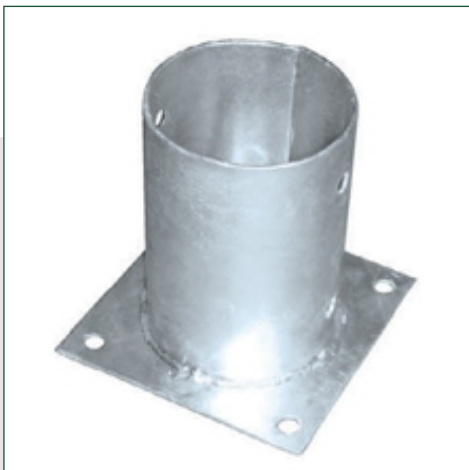

GROUND PLATES FOR ROUND POST

Certification:

ISO

Finish :

Hot-dip galvanized

Size
81x81x150mm
101x101x150mm
121x121x150mm

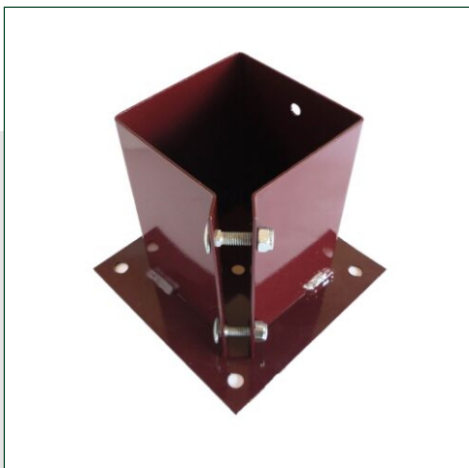

GROUND PLATES BOLT TYPE

Certification:

ISO

Finish :

Hot-dip galvanized

Size
70x70x150mm
75x75x150mm
90x90x150mm
100x100x150mm



GROUND PLATES
WEDGE GRIP

Certification:

ISO

Finish :

Hot-dip galvanized

Size
70x70x150mm
76x76x150mm
90x90x150mm
96x96x150mm
100x100x150mm



POLE ANCHORS
BOLT TYPE

Certification:

ISO

Finish :

Hot-dip galvanized

Size
70x70x600mm
75x75x600mm
75x75x750mm
90x90x600mm
100x100x750mm

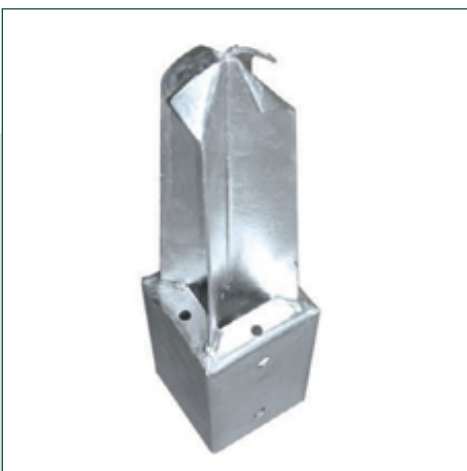

POLE ANCHORS
FOR CONCRETE

Certification:

ISO

Finish :

Hot-dip galvanized

Size
71x71x350mm
91x91x350mm

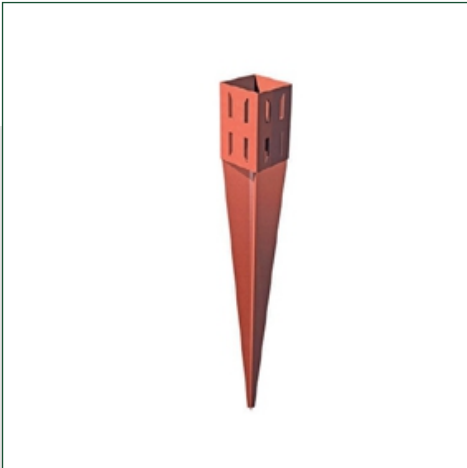

POLE ANCHORS WEDGE GRIP

Certification:

ISO

Finish :

Hot-dip galvanized

Size
70x70x600mm
75x75x600mm
75x75x750mm
90x90x600mm
100x100x750mm



ROTATABLE POLE ANCHORS FOR SQUARE POST

Certification:

ISO

Finish :

Hot-dip galvanized

Size
71x71x750mm
91x91x750mm



GROUND ANCHOR PLATE WITH SLOT

Certification:

ISO

Finish :

Hot-dip galvanized

Size
71x71x150mm
91x91x150mm



POLE ANCHOR WITH SLOT

Certification:

ISO

Finish :

Hot-dip galvanized

Size
71x71x750mm
71x71x900mm
91x91x750mm
91x91x900mm



SPIRAL POLE ANCHORS FOR SQUARE POST

Certification:

ISO

Finish :

Hot-dip galvanized

Size
71x71x650mm
91x91x650mm



SPIRAL POLE ANCHOR FOR ROUND POST

Certification:

ISO

Finish :

Hot-dip galvanized

Size
71x71x650mm
91x91x650mm



DOWEL PLATE SHORT

Certification:

ISO

Finish :

Hot-dip galvanized

Material: raw steel

Surface treatment: hot-dip galvanized

Base plate: 150 x 80 x 8mm

For posts: 60 x 40 mm

Recording: 55 x 34 x 15 x 2

Mounting type: screw-on



ANGLE PLATE

Certification:

ISO

Finish :

Hot-dip galvanized

Size

Plate: 94 x 100 mm

For posts: 60 x 40 mm

Mounting: 55 x 34 x 150 x 2 mm

Mounting bracket: 84 x 100 x 4 mm



DOWEL PLATE FOR GATE POST

Certification:

ISO

Finish :

Hot-dip galvanized

Size

Dowel plate with fence base 60 x 40 mm for metal fence posts

Technical data:
post holder (guide shaft) 55 x 35 mm
dowel plate 110 x 110 mm
post mounting height 190 mm
material thickness 2.0 mm weight:



**DOWEL
PLATE LONG**

Certification:

ISO

Finish :

Hot-dip galvanized

Size
70 x 70 mm
150 x 100 mm

Wood Connector

Post Support



L-TYPE POST SUPPORTS

Certification:

ISO

Finish :

Hot-dip galvanized

Size
70x60mm, 16x200mm
75x60mm, 16x200mm

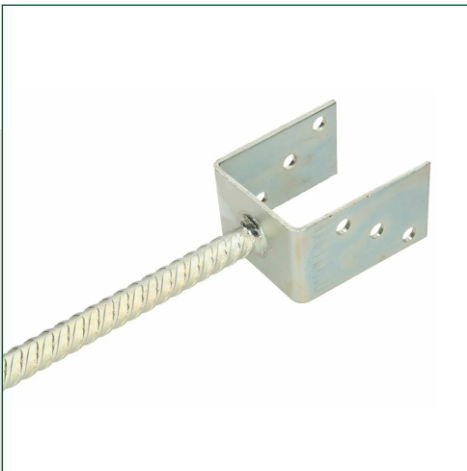

Y-TYPE POST SUPPORTS

Certification:

ISO

Finish :

Hot-dip galvanized

Size
71x300x4mm
81x300x4mm
91x300x4mm
101x300x4mm
121x300x4mm
141x300x4mm



U-TYPE POST SUPPORTS

Certification:

ISO

Finish :

Hot-dip galvanized

Size
71x150mm
81x150mm
91x150mm
101x150mm
111x150mm
121x150mm
141x150mm



**H-TYPE
POST SUPPORTS**

Certification:

ISO

Finish :

Hot-dip galvanized

Size
71x600x60x5mm
81x600x60x5mm
91x600x60x5mm
101x600x60x5mm
111x600x60x5mm
121x600x60x5mm
141x600x60x5mm



**T-TYPE
POST SUPPORTS**

Certification:

ISO

Finish :

Hot-dip galvanized

Size
50mm x 50mm
70mm x 70mm
75mm x 75mm
90mm x 90mm
100mm x 100mm
150mm x 150mm



**U-TYPE
POST SUPPORTS**

Certification:

ISO

Finish :

Hot-dip galvanized

Size
600x 90mm
600 x 100mm
600 x 125mm
600 x 140mm



I-TYPE POST SUPPORTS

Certification:

ISO

Finish :

Hot-dip galvanized

Size
50mm x 50mm
70mm x 70mm
75mm x 75mm
90mm x 90mm
100mm x 100mm
150mm x 150mm



U-TYPE POST SUPPORTS WITH BASE

Certification:

ISO

Finish :

Hot-dip galvanized

Size
71x200x50mm, 180x50mm
91x200x50mm, 180x50mm
101x200x50mm 180x50mm
121x200x50mm,180x50mm
141x200x50mm,200x50mm



BOLT DOWN POST SUPPORTS

Certification:

ISO

Finish :

Hot-dip galvanized

Size
50mm x 50mm
70mm x 70mm
75mm x 75mm
90mm x 90mm
00mm x 100mm
150mm x 150mm



T-BLADE POST SUPPORTS

Certification:

ISO

Finish :

Hot-dip galvanized

Size
80 x 80 Base (250mm Blade)
110x 110Base (275mm Blade)
140 x 140 Base (300mm Blade)
180 x 180Base (350mm Blade)

Wood Connector

Post Caps

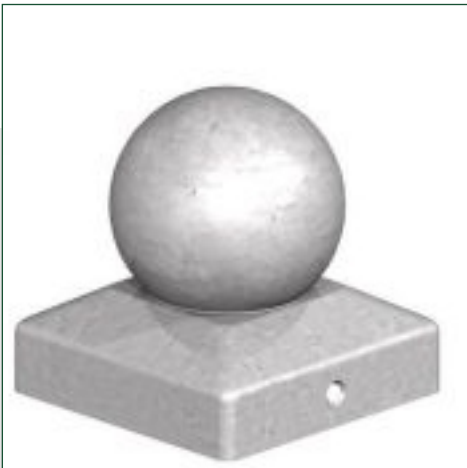

BALL TOP POST CAPS

Certification:

ISO

Finish :

Hot-dip galvanized

Size
71x71mm
76x76mm
91x91mm
96x96mm
101x101mm
121x121mm



BALL TOP POST CAPS

Certification:

ISO

Finish :

Black Powder
Coating

Size
71x71mm
76x76mm
91x91mm
96x96mm
101x101mm
121x121mm



BALL TOP POST CAPS

Certification:

ISO

Finish :

Stainless Steel

Size
71x71mm
76x76mm
91x91mm
96x96mm
101x101mm
121x121mm



**BALL TOP
POST CAPS**

Certification:

ISO

Finish :

Solid Copper

Size
71x71mm
76x76mm
91x91mm
96x96mm
101x101mm
121x121mm

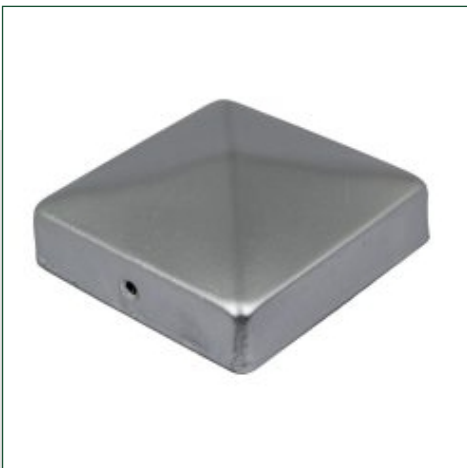

**PYRAMID
POST CAPS**

Certification:

ISO

Finish :

Hot-Dip Galvanized

Size
71x71mm
76x76mm
91x91mm
96x96mm
101x101mm
121x121mm



**PYRAMID
POST CAPS**

Certification:

ISO

Finish :

Black Powder Coating

Size
71x71mm
76x76mm
91x91mm
96x96mm
101x101mm
121x121mm

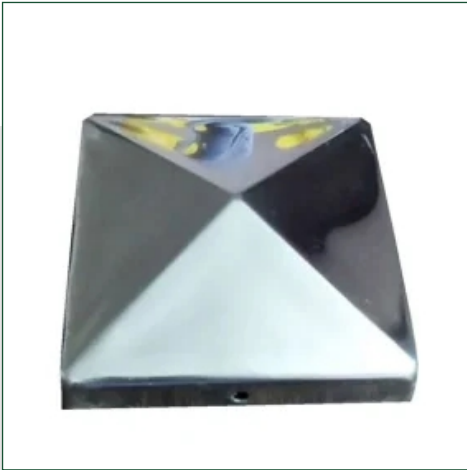

**PYRAMID
POST CAPS**

Certification:

ISO

Finish :

Stainless Steel

Size
71x71mm
76x76mm
91x91mm
96x96mm
101x101mm
121x121mm



**PYRAMID
POST CAPS**

Certification:

ISO

Finish :

Solid Copper

Size
71x71mm
76x76mm
91x91mm
96x96mm
101x101mm
121x121mm



**ROUND
POST CAPS**

Certification:

ISO

Finish :

Hot-Dip Galvanized

Size
Ø 61mm
Ø 81 mm
Ø 101 mm



**ROUND
POST CAPS**

Certification:

ISO

Finish :

Black Powder Coating

Size
Ø 61mm
Ø 81mm
Ø 102mm



**ROUND
POST CAPS**

Certification:

ISO

Finish :

Stainless Steel

Size
Ø 61mm
Ø 81mm
Ø 103mm



**ROUND
POST CAPS**

Certification:

ISO

Finish :

Solid Copper

Size
Ø 61mm
Ø 81mm
Ø 104mm

Wood Connector

Adjustable Post Supports



ADJUSTABLE I-TYPE POST SUPPORTS

Certification:

ISO

Finish :

Hot-dip galvanized



ADJUSTABLE L-TYPE POST SUPPORTS

Certification:

ISO

Finish :

Stainless Steel

Size
Plate anchor 160mm (Fixed nut)
Instortanker 300mm
Instortanker 500mm
Adjustable collapse anchor 300mm
Adjustable collapse anchor 400mm
Adjustable collapse anchor 500mm
Adjustable collapse anchor 500mm (hinge)
Plate anchor 90mm (Fixed nut / light)
Plate anchor 160mm (adjustable nut)



ADJUSTABLE Y-TYPE POST SUPPORT WITH LONG NUT

Certification:

ISO

Finish :

Hot-Dip Galvanized

Size
Plate anchor 160mm (Fixed nut)
Instortanker 300mm
Instortanker 500mm
Adjustable collapse anchor 300mm
Adjustable collapse anchor 400mm
Adjustable collapse anchor 500mm
Adjustable collapse anchor 500mm (hinge)
Plate anchor 90mm (Fixed nut / light)
Plate anchor 160mm (adjustable nut)



**ADJUSTABLE
POST SUPPORT
WITH LONG NUT**

Certification:
ISO
Finish :
Black Powder Coating

Size
Plate anchor 160mm (Fixed nut)
Instortanker 300mm
Instortanker 500mm
Adjustable collapse anchor 300mm
Adjustable collapse anchor 400mm
Adjustable collapse anchor 500mm
Adjustable collapse anchor 500mm (hinge)
Plate anchor 90mm (Fixed nut / light)
Plate anchor 160mm (adjustable nut)



**ADJUSTABLE
POST SUPPORT**

Certification:
ISO
Finish :
Black Powder Coating

Size
Plate anchor 160mm (Fixed nut)
Instortanker 300mm
Instortanker 500mm
Adjustable collapse anchor 300mm
Adjustable collapse anchor 400mm
Adjustable collapse anchor 500mm
Adjustable collapse anchor 500mm (hinge)
Plate anchor 90mm (Fixed nut / light)
Plate anchor 160mm (adjustable nut)



**ADJUSTABLE
POST SUPPORT**

Certification:
ISO
Finish :
Black Powder Coating

Size
Plate anchor 160mm (Fixed nut)
Instortanker 300mm
Instortanker 500mm
Adjustable collapse anchor 300mm
Adjustable collapse anchor 400mm
Adjustable collapse anchor 500mm
Adjustable collapse anchor 500mm (hinge)
Plate anchor 90mm (Fixed nut / light)
Plate anchor 160mm (adjustable nut)



ADJUSTABLE THREADED POST SUPPORTS

Certification:

ISO

Finish :

Black Powder Coating

Size
Plate anchor 160mm (Fixed nut)
Instortanker 300mm
Instortanker 500mm
Adjustable collapse anchor 300mm
Adjustable collapse anchor 400mm
Adjustable collapse anchor 500mm
Adjustable collapse anchor 500mm (hinge)
Plate anchor 90mm (Fixed nut / light)
Plate anchor 160mm (adjustable nut)



ADJUSTABLE T-TYPE POST SUPPORT WITH BASE PLATE

Certification:

ISO

Finish :

Black Powder Coating

Size
Plate anchor 160mm (Fixed nut)
Instortanker 300mm
Instortanker 500mm
Adjustable collapse anchor 300mm
Adjustable collapse anchor 400mm
Adjustable collapse anchor 500mm
Adjustable collapse anchor 500mm (hinge)
Plate anchor 90mm (Fixed nut / light)
Plate anchor 160mm (adjustable nut)



ADJUSTABLE T-TYPE POST SUPPORT

Certification:

ISO

Finish :

Black Powder Coating

Size
Plate anchor 160mm (Fixed nut)
Instortanker 300mm
Instortanker 500mm
Adjustable collapse anchor 300mm
Adjustable collapse anchor 400mm
Adjustable collapse anchor 500mm
Adjustable collapse anchor 500mm (hinge)
Plate anchor 90mm (Fixed nut / light)
Plate anchor 160mm (adjustable nut)



**ADJUSTABLE
Y-TYPE
POST SUPPORT I**

Certification:

ISO

Finish :

Hot-Dip Galvanized

Size
Plate anchor 160mm (Fixed nut)
Instortanker 300mm
Instortanker 500mm
Adjustable collapse anchor 300mm
Adjustable collapse anchor 400mm
Adjustable collapse anchor 500mm
Adjustable collapse anchor 500mm (hinge)
Plate anchor 90mm (Fixed nut / light)
Plate anchor 160mm (adjustable nut)



**ADJUSTABLE
Y-TYPE
POST SUPPORT II**

Certification:

ISO

Finish :

Black Powder Coating

Size
Plate anchor 160mm (Fixed nut)
Instortanker 300mm
Instortanker 500mm
Adjustable collapse anchor 300mm
Adjustable collapse anchor 400mm
Adjustable collapse anchor 500mm
Adjustable collapse anchor 500mm (hinge)
Plate anchor 90mm (Fixed nut / light)
Plate anchor 160mm (adjustable nut)



**ADJUSTABLE Y-TYPE
POST SUPPORT
WITH LONG NUT**

Certification:

ISO

Finish :

Black Powder Coating

Size
Plate anchor 160mm (Fixed nut)
Instortanker 300mm
Instortanker 500mm
Adjustable collapse anchor 300mm
Adjustable collapse anchor 400mm
Adjustable collapse anchor 500mm
Adjustable collapse anchor 500mm (hinge)
Plate anchor 90mm (Fixed nut / light)
Plate anchor 160mm (adjustable nut)



**ADJUSTABLE Y-TYPE
POST SUPPORT
WITH LONG NUT**

Certification:

ISO

Finish :

Hot-Dip Galvanized

Size
Plate anchor 160mm (Fixed nut)
Instortanker 300mm
Instortanker 500mm
Adjustable collapse anchor 300mm
Adjustable collapse anchor 400mm
Adjustable collapse anchor 500mm
Adjustable collapse anchor 500mm (hinge)
Plate anchor 90mm (Fixed nut / light)
Plate anchor 160mm (adjustable nut)



**ADJUSTABLE Y-TYPE
POST SUPPORTS
WITH LONG NUT &
BASE PLATE**

Certification:

ISO

Finish :

Black Powder Coating

Size
Plate anchor 160mm (Fixed nut)
Instortanker 300mm
Instortanker 500mm
Adjustable collapse anchor 300mm
Adjustable collapse anchor 400mm
Adjustable collapse anchor 500mm
Adjustable collapse anchor 500mm (hinge)
Plate anchor 90mm (Fixed nut / light)
Plate anchor 160mm (adjustable nut)



**ADJUSTABLE
Y-TYPE
POST SUPPORTS III**

Certification:

ISO

Finish :

Black Powder Coating

Size
Plate anchor 160mm (Fixed nut)
Instortanker 300mm
Instortanker 500mm
Adjustable collapse anchor 300mm
Adjustable collapse anchor 400mm
Adjustable collapse anchor 500mm
Adjustable collapse anchor 500mm (hinge)
Plate anchor 90mm (Fixed nut / light)
Plate anchor 160mm (adjustable nut)

Wood Connector

INDOOR WOOD CONNECTORS



L - BRACKET WITH SCREWS

Certification:

ISO

Finish :

Hot-dip galvanized

Size

Set of 4 Fence Brackets
Galvanised L Shape 38 x
34 mm



ANGLE CONNECTOR

Certification:

ISO

Finish :

Hot-dip galvanized

Size

Size	
42x125x12m	60x60x60mm
20x40x40mm	60x60x60mm
30x25x30mm	60x80x80mm
40x40x40mm	60x100x100m
40x50x50mm	80x60x60mm
40x60x60mm	80x80x80mm
40x60x60mm	80x100x100m
50x60x60mm	100x40x40m
50x60x60mm	100x60x60m
60x40x40mm	100x100x100
60x40x40mm	200x40x40m



ANGLE CONNECTORS WITH RIB

Certification:

ISO

Finish :

Hot-dip galvanized

Size
55x70x70mm
55x70x70mm
60x90x90mm
60x90x90mm
65x90x90mm
90x105x105mm



ANGLE CONNECTORS ADJUSTABLE

Certification:

ISO

Finish :

Hot-dip galvanized



ANGLE CONNECTORS

Certification:

ISO

Finish :

Hot-dip galvanized

Size
40x300mm
40x200mm
40x400mm

Size
55x70x70mm
55x70x70mm
60x90x90mm
60x90x90mm
65x90x90mm
90x105x105mm

ANGLE CONNECTORS WITHOUT RIB

Certification:

ISO

Finish :

Hot-dip galvanized



JOIST HANGERS TYPE B

Certification:

ISO

Finish :

Hot-dip galvanized

Size
60x100mm
60x130mm
70x125mm
70x155mm
80x120mm
80x150mm
80x180mm

Size	
50x150mm	71x171mm
46x96mm	71x196mm
46x121mm	71x221mm
50x12mm	75x17mm
59x146mm	75x200mm
59x156mm	75x22mm
59x171mm	96x196mm
63x160mm	100x250mm

JOIST HANGERS TYPE C

Certification:

ISO

Finish :

Hot-dip galvanized





JOIST HANGERS

TYPE A

Certification:

ISO

Finish :

Hot-dip galvanized

Size	
	60x160mm
80x180mm	62x158mm
25x117mm	63x93mm
32x114mm	63x98mm
38x131mm	63x118mm
40x8mm	63x128mm
40x110mm	63x158mm
40x148mm	63x188mm
46x10mm	71x9 71x12mm
46x144mm	71x154mm
50x70mm	71x184mm
50x100mm	75x12 75x130mm
50x10mm	75x15 mm
50x143mm	75x18mm
59x100mm	75x2mm
59x138mm	80x120mm
59x160mm	80x150mm
59x190mm	100x140mm
60x80mm	100x170mm
60x100mm	120x160mm
60x130mm	120x190mm

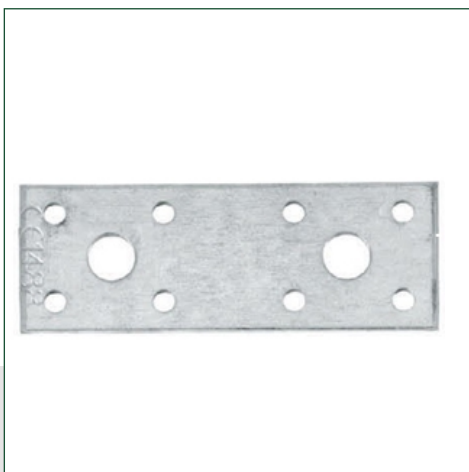

PERFORATED

PLATES TYPE B

Certification:

ISO

Finish :

Hot-dip galvanized

Size
40x180mm
40x100mm
55x135mm
65x176mm
90x200mm



PERFORATED STRIPS

Certification:

ISO

Finish :

Hot-dip galvanized

Size
10mx17mm [0,8mm]
5mx25mm [1mm]
10mx12mm (in cassette) [0,8mm]
10mx12mm [0,8mm]
10mx14mm [0,8mm]
10mx17mm (in cassette) [0,8mm]
10mx19mm [0,8mm]
10mx25mm (in cassette) [1mm]
10mx25mm [0,8mm]
10mx25mm [1mm]
10mx27mm [0,8mm]
12mm [0,8mm]
17mm [0,8mm]
25mm [0,8mm]
25mx12mm [0,8mm]
25mx17mm [0,8mm]
25mx25mm [1mm]
40mm

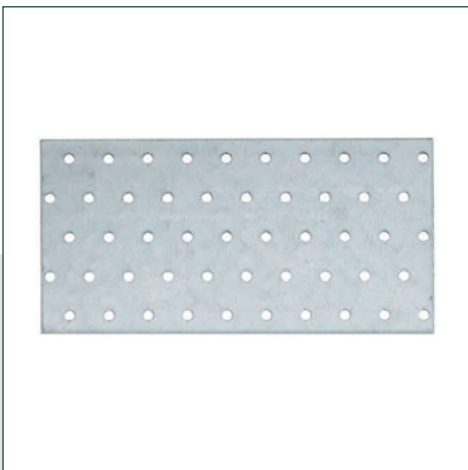

PERFORATED PLATES TYPE A

Certification:

ISO

Finish :

Hot-dip galvanized

Size	60x140mm
100x240mm	60x200mm
40x60mm	60x240mm
40x80mm	80x200mm
40x100mm	80x240mm
40x120mm	80x300mm
40x160mm	100x140mm
40x200mm	100x200mm
40x240mm	100x300mm



PURLIN ANCHORS

Certification:

ISO

Finish :

Hot-dip galvanized

Size
170X35
210X35



UNIVERSAL CONNECTORS

Certification:

ISO

Finish :

Hot-dip galvanized

Size
32x170mm (right)
32x170mm (links)
32x210mm (links)
32x210mm (right)
32x250mm (links)
32x250mm (right)
32x290mm (links)
32x290mm (right)



PERFORATED STRIPS

Certification:

ISO

Finish :

Hot-dip galvanized

SCAFFOLDING & FORMWORKS

American Frame Scaffolding

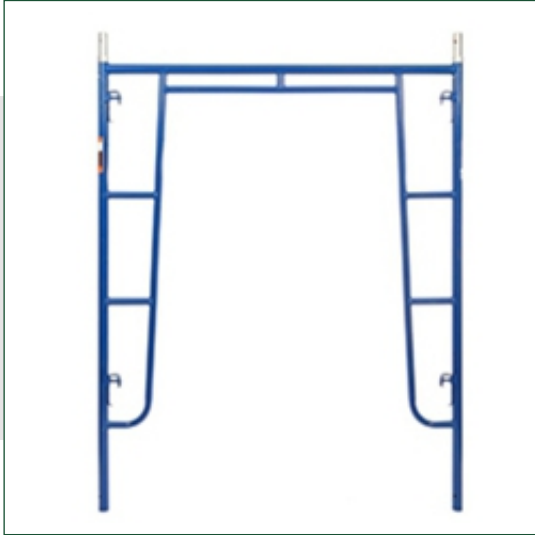

Walk-Thru Frame

Mason Frame



Double Box Frame

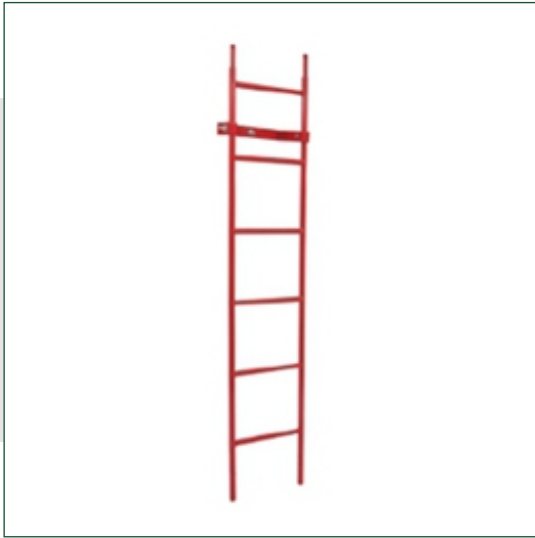

**6 Ft Access
Ladder and Bracket**

**6 Multi Function
Scaffolding Baker**

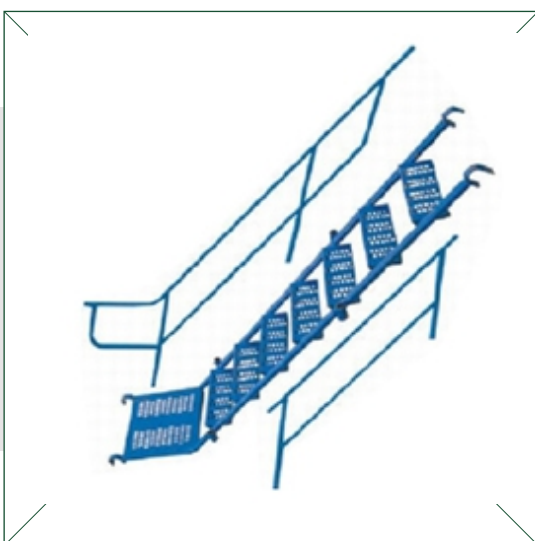

**7 or 8 Steel
Stair Unit**



**42 Guardrail
Post W Leg Frame**

**Shoring Angle
Iron Cross Brace**

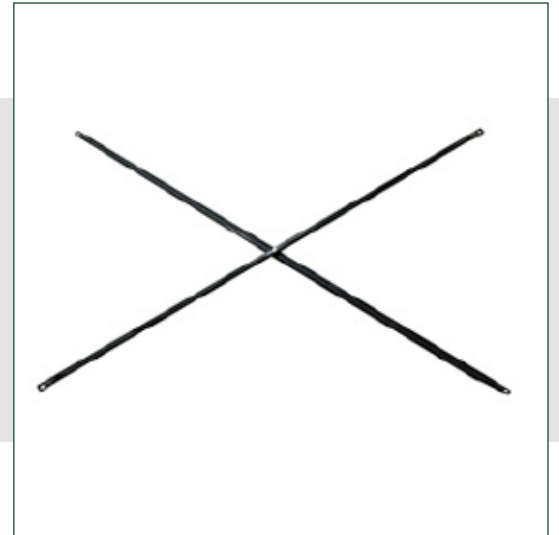

**20 Heavy Duty
Saddle Bracket**



**Wall
Tie Bar**

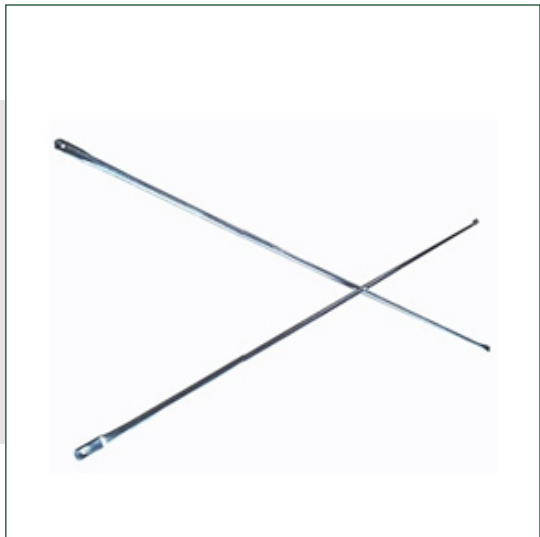

**Cross
Brace**



**4 x 6
Shoring Frame**

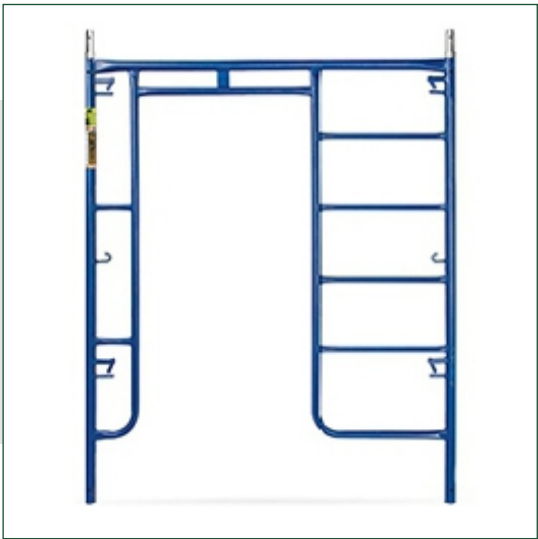

**Walk Thru
Ladder**



**Snap on
Frame**



**2 "x 6'4"
Narrow Frame**

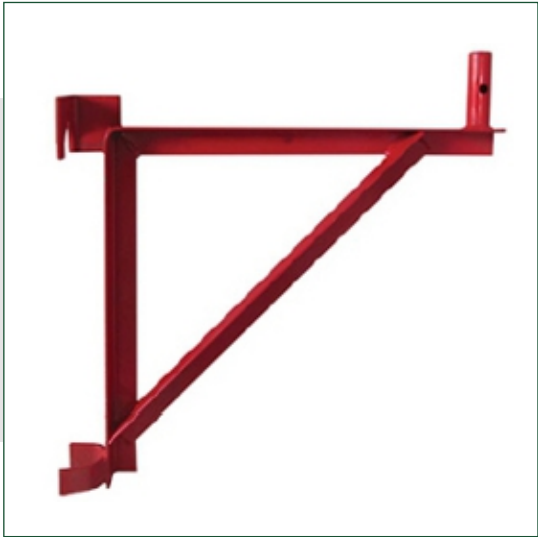

**20" Side
Bracket**

SCAFFOLDING & FORMWORKS

Frame Scaffolding



Rolling Scaffold Tower

Certification: ISO

Finish : Powder Coating

A Frame

Certification: ISO

Finish : Powder Coating



H Frame

Certification: ISO

Finish : Powder Coating



Cross Brace

Certification: ISO

Finish : Galvanized

Joint Pin

Certification: ISO

Finish : Galvanized



Locking Pin

Certification: ISO

Finish : Galvanized

SCAFFOLDING & FORMWORKS

Fork Heads and Base Jacks



U HEAD JACK

FORK HEAD JACK



FORK HEAD - HOLE



FORK HEAD – U STRIP

FORK HEAD SLOTTED



FORK HEAD – ROD (HOLES IN PLATE)

ADJUSTABLE BASE JACK



**ADJUSTABLE BASE
JACK WITH LOCKING
WING NUT**



**SWIVEL BASE JACK
LIGHT DUTY**



**JACK
NUT-CASTED**



**JACK
NUT-FORGED**



SCAFFOLDING & FORMWORKS

Scaffolding Planks and
Ringlock Scaffolding

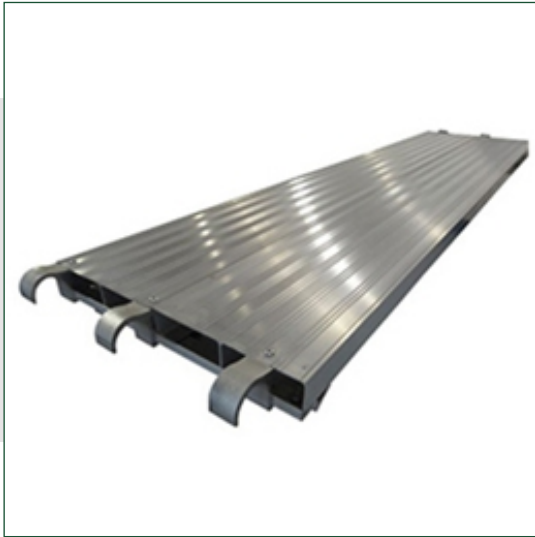

Walk Thru Frame

**Plank
U Type**

Size
5 x 19.25' Aluminum Planks
6 x 19.25' Aluminum Planks
7 x 19.25' Aluminum Planks
8 x 19.25' Aluminum Planks
10 x 19.25' Aluminum Planks

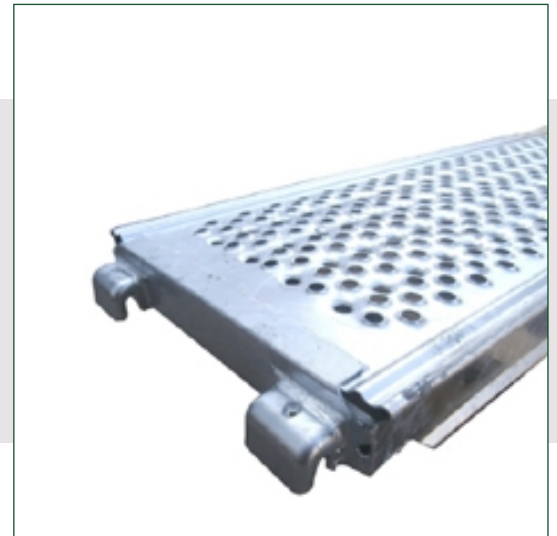

Ledger Head Brace Head Rosette



**Stairway
Stringer**

**Ringlock
Base Collar**



**Ringlock Reosette
Coupler (Clamp)**

**Ringlock Wedge
Head Coupler**



SCAFFOLDING & FORMWORKS

**Kwikstage
Scaffolding**



Galvanized Kwikstage

Standard For Kwikstage



Aluminum Stairs

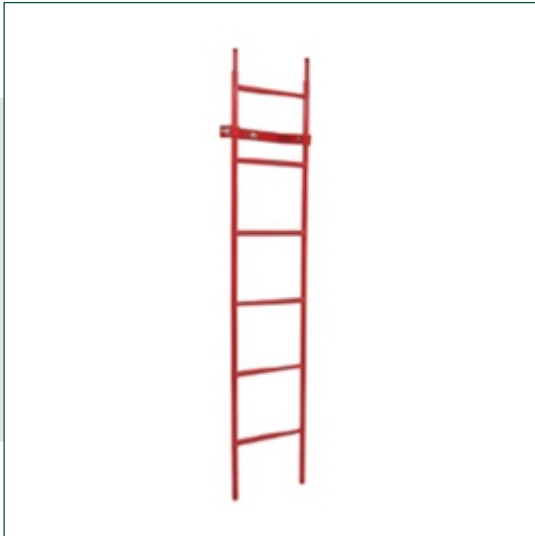

**6 Ft Access
Ladder and Bracket**

**6" Multi Function
Scaffolding Baker**

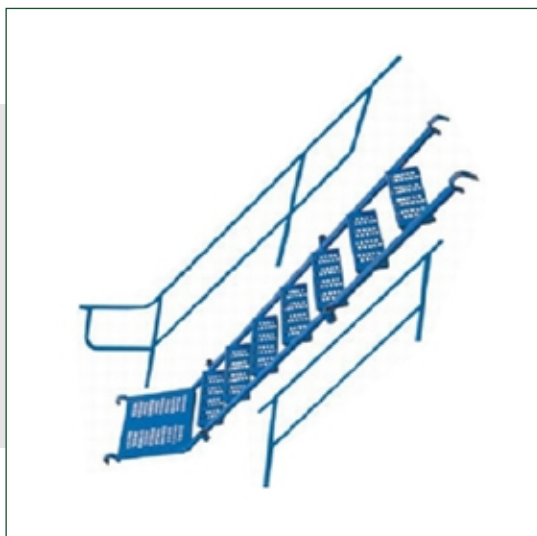

**7" or 8 "
Steel Stair Unit**



Transom

**Two Board Hop
Up Bracket**



**Diagonal
Brace**



Ledger

**Hop Up
Bracket**



**Three Board
Hop Up Bracket**

SCAFFOLDING & FORMWORKS

Cuplock Scaffolding



Cuplock Scaffold



Intermediate Transom

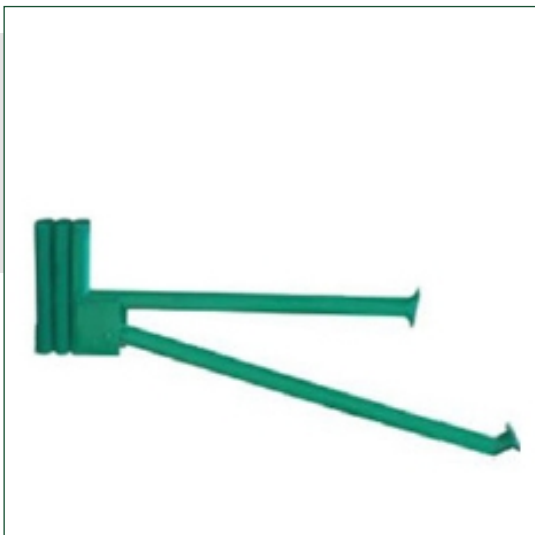

Cantilever

Diagonal Brace



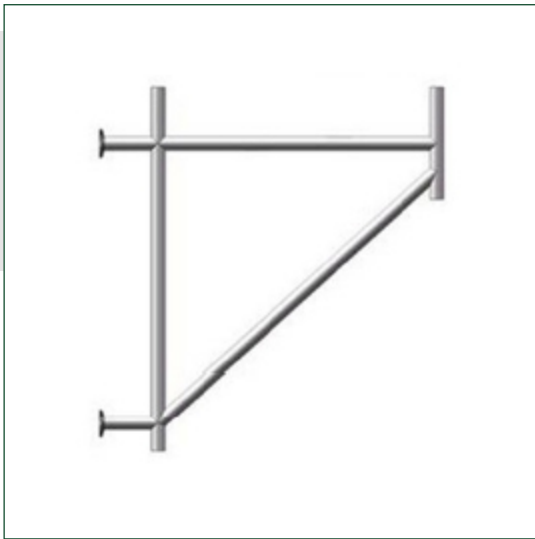

Cantilever Beam Frame



Accessories



Standard

Ledger



SCAFFOLDING & FORMWORKS

Tubes and
Clamps



Pressed Swivel Coupler



Drop Forged Scaffolding Coupler



Pressed Scaffold Couplers



Casted Scaffold Coupler





**Drop Forge
Double Coupler**



Pressed Fixed Coupler



HDG Scaffolding Tubes

**Drop Forged
Swivel Coupler**



GUARD

RAILS



Gkg-5001 Guard Rail

with Block

Size : 40mm



Gkg-5002 Guard Rail

with Block

Size : 25mm



Gkg-5003 Guard Rail



Gkg-5004 Guard Rail

with Block





Gkg-5005

Guard Rail

With Block (Painted)

Gkg-5006

Guard Rail

With Block (Painted)

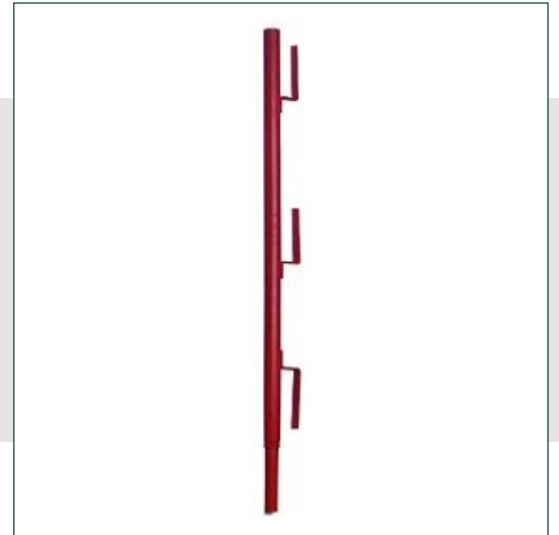

Gkg-5007

Guard Rail

With Block (Painted)



Chain Link Fence



Chain Link Fence

PVC Coated Chain

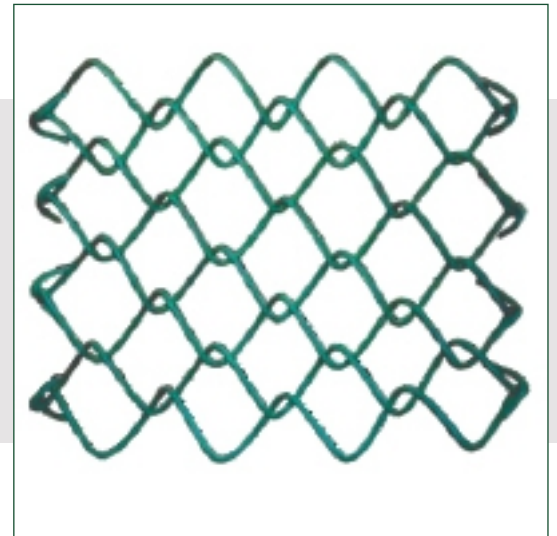

Barbed Wire



Concertina Coils

Weld Mesh

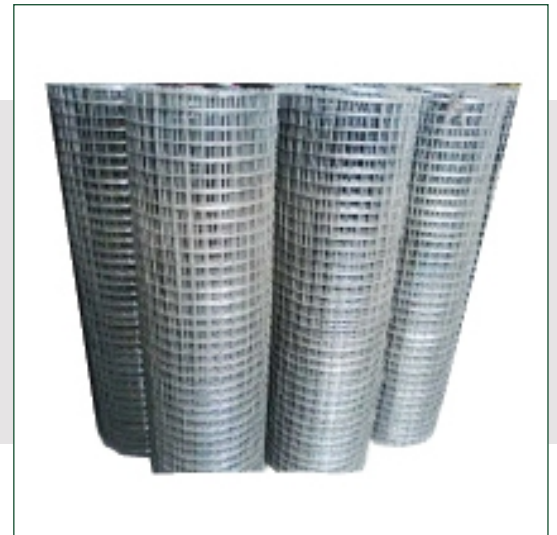

**PVC Coated
Chain Link Fence**



Diagonal Brace

Leg Bridge Post



Girth Diagonal Brace

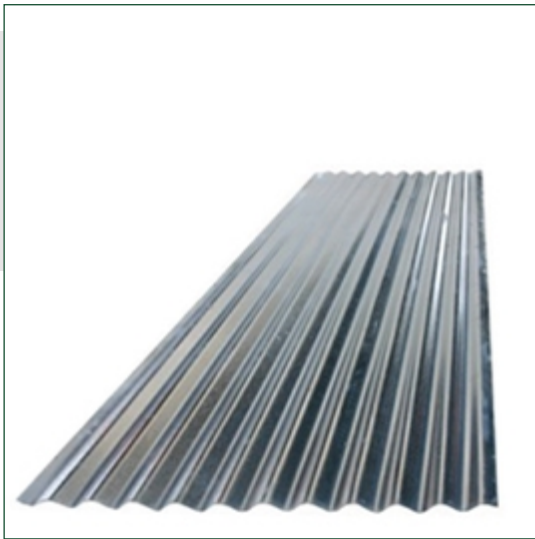

Corrugated Sheet



Duplex Nails

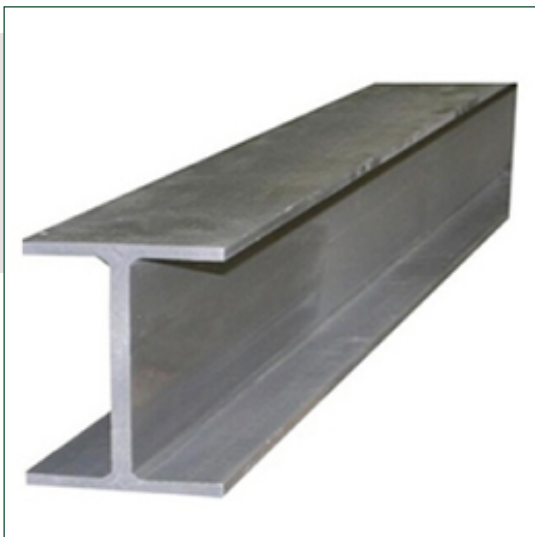

Junior Beams



Stud Clamps

Post Bridge Leg



Header Clamps

Bridge Leg Bundles



Right Angle Swivel Clamps



Nuts and Coupler

Die: 17, 23 and 30 mm

Finish :Self Finish,
Electro Galvanised

Size
30 mm
50 mm
100 mm
120 mm



Hexagonal Nut

Die: 17, 23 and 30 mm

Finish :Self Finish,
Electro Galvanised

Size
30 mm
50 mm
100 mm
120 mm



Lock Nut

Die: 17, 23 and 30 mm

Finish :Self Finish,
Electro Galvanised

Size
30 mm
50 mm
100 mm
120 mm



2 Wing Nut

Die: 17, 23 and 30 mm

Finish :Self Finish,
Electro Galvanised

Size
30 mm
50 mm
100 mm
120 mm



3 Wing Anchor Nut

Die: 17, 23 and 30 mm

Finish :Self Finish,
Electro Galvanised

Size
30 mm
50 mm
100 mm
120 mm



3 Wing Nut

Die: 17, 23 and 30 mm

Finish :Self Finish,
Electro Galvanised

Size
30 mm
50 mm
100 mm
120 mm



3 Wing Nut

Die: 17, 23 and 30 mm

Finish :Self Finish,
Electro Galvanised

Size
30 mm
50 mm
100 mm
120 mm



3 Wing Nut

Die: 17, 23 and 30 mm

Finish :Self Finish,
Electro Galvanised

Size
30 mm
50 mm
100 mm
120 mm



3 Wing Nut

Die: 17, 23 and 30 mm

Finish :Self Finish,
Electro Galvanised

Size
30 mm
50 mm
100 mm
120 mm



Hussor Nut

Die: 17, 23 and 30 mm

Finish :Self Finish,
Electro Galvanised

Size
30 mm
50 mm
100 mm
120 mm



Hussor Nut

Die: 17, 23 and 30 mm

Finish :Self Finish,
Electro Galvanised

Size
30 mm
50 mm
100 mm
120 mm



Hussor Nut

Die: 17, 23 and 30 mm

Finish :Self Finish,
Electro Galvanised

Size
30 mm
50 mm
100 mm
120 mm



Nut With Turning Plate

Die: 17, 23 and 30 mm

Finish :Self Finish,
Electro Galvanised

Size
30 mm
50 mm
100 mm
120 mm



Nut With Turning Plate

Die: 17, 23 and 30 mm

Finish :Self Finish,
Electro Galvanised

Size
30 mm
50 mm
100 mm
120 mm



Nut With Turning Plate

Die: 17, 23 and 30 mm

Finish :Self Finish,
Electro Galvanised

Size
30 mm
50 mm
100 mm
120 mm



Nut With Turning Plate

Die: 17, 23 and 30 mm

Finish :Self Finish,
Electro Galvanised

Size
30 mm
50 mm
100 mm
120 mm



Nut With Turning Plate

Die: 17, 23 and 30 mm

Finish :Self Finish,
Electro Galvanised

Size
30 mm
50 mm
100 mm
120 mm



Outinord Nut

Die: 17, 23 and 30 mm

Finish :Self Finish,
Electro Galvanised

Size
30 mm
50 mm
100 mm
120 mm



Outinord Nut

Die: 17, 23 and 30 mm

Finish :Self Finish,
Electro Galvanised

Size
30 mm
50 mm
100 mm
120 mm



Sateco Nut

Die: 17, 23 and 30 mm

Finish :Self Finish,
Electro Galvanised

Size
30 mm
50 mm
100 mm
120 mm



Sateco Nut

Moveable Plate

Die: 17, 23 and 30 mm

Finish :Self Finish,
Electro Galvanised

Size
30 mm
50 mm
100 mm
120 mm



Rectangular Plate

Die: 17, 23 and 30 mm

Finish :Self Finish,
Electro Galvanised

Size
30 mm
50 mm
100 mm
120 mm



Square Plate

Die: 17, 23 and 30 mm

Finish :Self Finish,
Electro Galvanised

Size
30 mm
50 mm
100 mm
120 mm